

SKID STEER ARTICULATING BRUSH CUTTER MANUAL

Model:ABC-13-125A



Content

I . GENERAL SAFETY PRECAUTIONS	1
Operator Safety	1
Skid Steer Requirements	2
II .ARTICULATING BRUSH CUTTER DIMENSIONS	4
III.BASIC PARAMETER OF ARTICULATING BRUSH CUTTER	6
IV. INSTALLATION & SET-UP	8
Using Your Implement Connecting Cutter to Skid Steer	8
Connecting the Coupler to the Attachment	8
V. OPERATING INSTRUCTIONS	9
Cutter Boom Controls	9
Engaging Cutter Drive	9
Starting the Cutter	10
Stopping the Cutter	10
Getting Familiar with the Attachment	10
Adjusting Cutter Height & Level	12
Swinging Cutter	12
Before Cutting	13
Vertical Cutting	14
VI.HYDRAULIC ELECTRIC CONTROL SYSTEM	15
VII.MAINTENANCE	19
Blade Removal & Replacement	19
Blades & Holder	19
Every Week	20
VIII.TROUBLESHOOTING	21
IX.BOLT TORQUE SPECIFICATIONS	23
GENERAL TORQUE SPECIFICATION TABLES	23
METRIC BOLT TORQUE SPECIFICATIONS	23

I . GENERAL SAFETY PRECAUTIONS

Operator Safety

It is the responsibility of the operator using this attachment to be acquainted with the safe operation. In addition to reading this manual, it is important that the operator read the skid steer's operation manual and follow its manufacturer's recommendations!

& Before raising, lowering or swinging the cutter, make sure the area is clear of bystanders or objects.

Machinery parts sometimes have sharp edges. Wear work gloves when moving parts. Always use caution around cutting blades as they are often very sharp.

Never use drugs or alcoholic beverages when operating or servicing this piece of equipment.

Always wear the proper personal protective equipment when servicing or operating this piece of equipment. Never service or operate this attachment with bare feet, sandals, or other light footwear.

Always use eye protection when operation. Mount this attachment on a skid steer equipped with thermoplastic polycarbonate door panel and side panels.

Speed Kills! Operate this implement at a safe working speed. When transporting the implement, keep a safe speed to avoid losing control of the attachment or prime mover.

Keep a safe distance between the implement and objects (tree stumps, large rocks, buildings, etc.). Contact between these objects with the implement or prime mover could result in a loss of control or damage to the implement.

Before operating this implement, check all hardware (bolts, nuts, pins, cotter pins, etc.) are in the correct position and tightened.

Stop the engine on the skid steer and set the brake to avoid the

implement from rolling forward or backward while leaving the prime mover.

Store this machine in an area not frequented by children.

Allow no riders on this attachment. Keep all bystanders away from the attachment during operation.

Always replace worn, torn or missing safety decals before operating.

Never operate the cutter when bystanders are within 300 feet of the working area.

Use caution when working on or near the machine's battery. Do not smoke near the battery as battery vapors could ignite.

Skid Steer Requirements

The Articulating Brush Cutter should only be used on skid steers with a minimum lift capacity of 1800 lbs. and with a minimum weight of 6500 lbs with the bucket removed. A skid steer equipped with tracks will provide superior stability in this application.

You will install the electric joystick that accompanies this attachment or your skid steer must be equipped with an auxiliary electric option with an electric connector mounted on the machine's loader lift arm from the skid steer manufacturer. To complete the connection, the mating connector on the loader arm needs to match the connector from the attachment.

A 12 V power source coming directly from the battery or from any other circuit that is energized all the time could result in death or serious injury if the attachment control switch is accidentally bumped when the operator is entering or exiting the skid steer with the engine running.

Always refer to the polarity symbols printed on the top of the battery. Refer to the markings on the battery to determine the location of the negative (-) cable. When removing the battery cables from the battery, always remove the negative cable first and reinstall the negative cable last.

DO NOT smoke around a battery, or use anything that produces an open flame or spark to avoid an explosion that could result in death or serious injury.

The 12V power source for this attachment should be connected into the skid steer's Operator Presence System that cuts the electrical power to the attachment shift valves if the operator's safety restraint bar is raised or the seat switch is disengaged when the operator raises from the seat.

When using the provided joystick, route the wiring harness to the pivot point of the loader arm and tie it with plastic cable ties to the inside of the loader arm to prevent snagging the harness with branches. After installing the harness, check that the harness is free from any tension when raising and lowering the loader arm through its complete cycle.

To protect the operator from any flying debris, it is important that the skid steer is equipped with a thermoplastic polycarbonate windshield or similar.

⚠ DANGER



High Pressure Fluid Hazard.
High pressure fluid leak will pierce skin.
Release pressure before working on system.
Detect leaks with wood or cardboard. Wear sturdy gloves and goggles. NEVER use fingers.
Fluid injected in skin must be surgically removed by trained doctor immediately or gangrene will result.
Fluid injected into skin will injure or kill.

HLW002

⚠ DANGER



Flying Object Crash Hazard
All equipment required to be used during an emergency response must be securely fastened.
Loose items may injure or kill during a crash.

HLW003A

⚠ WARNING



CRUSH HAZARD
Keep clear

HLW008

⚠ WARNING



Read and understand operator's manual and all other safety instructions before using this equipment.

HLW012

LandHonor POWERFUL ATTACHMENT TOOLS				
Model	ABC-13-125A	Weight	890	lbs
Serial NO.	HL*****	Max pressure	3000	PSI
Max Head Curl Degree	125°	Flow Range	14-20	GPM
Year	202*	Cutting Width	42	in
Email: service@landhonor.com				



DANGER STAY BACK

II .ARTICULATING BRUSH CUTTER DIMENSIONS

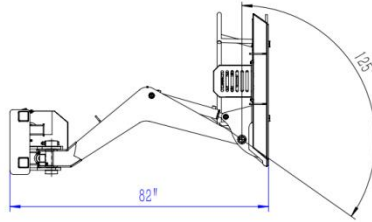
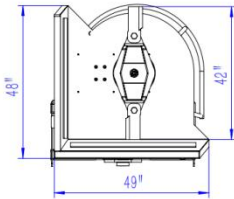
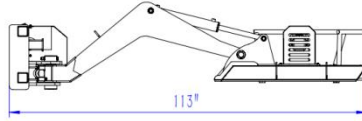

III. BASIC PARAMETER OF ARTICULATING BRUSH CUTTER

No.	Item	Parameter	Remark
1	Overall Length	82" (vertical) 113" (tilt)	
2	Overall wide	49"	
3	Overall height	48"	
4	Cutting Width	42"	
5	Material Cutting	Up to 5 in diameter	
6	Cutting Blades	9/16x11.5x5	2 Blades
7	Max Swing Degree	90°	
8	Max Head Tilt Degree	35°	
9	Hydraulic Flow Required	14-20GPM	
10	Max. pressure of oil	2000-2500 psi	
11	Direct Current Voltage	DC12V	
12	Check Valve	CIT-03 G3/8	
13	hydraulic cylinder	2.5"x1.5"x16"	Stroke 16"
14	hydraulic cylinder	2"x1.25"x8"	Stroke 8"
15	hydraulic control valve Flow	25GPM	
16	hydraulic control valve pressure	3500 psi	
17	Gearbox	XH30.192Z.01L/03L	
	Speed Increasing Ratio	1:1.92	
18	Chain Roller	No.50	Chain Link 16
19	Weight	860 lbs	



20 GPM MA

IV. INSTALLATION & SET-UP

Using Your Implement Connecting Cutter to Skid Steer

Verify that the hydraulic hoses and wiring harness are clear of the front of the attaching plate on the attachment and that the mounting plate is free of dirt and debris. If clear, move the skid steer to proximity of attachment plate. Tilt the skid steer coupler forward to align the coupling point with the upper part on the attachment plate and raise the coupler slightly.

Connecting the Coupler to the Attachment

When the top edge of the coupler is seated in the top part of the coupler plate, roll the skid steer tilt function back until the attaching plate is flat against the skid steer coupler. Lock down the coupler levers.

Wipe off any dirt or dust from the male or female hydraulic flat-face couplers with a clean rag before attaching the hoses to keep contaminants from entering the hydraulic system.

Connect the cutter hydraulic hoses to the auxiliary circuit connectors on the skid steer. Connect the electrical wiring harness to the appropriate connector on the skid steer.

Check the surrounding area for bystanders and clear it before starting the skid steer or attachment.

Before operating the attachment, always visually inspect and verify that the coupler locking pins are fully engaged through the latch slots in the attachment plate.

Never enter the area underneath the coupler or any part of the attachment when it is in the raised position to avoid an accident resulting in death or serious injury.

V. OPERATING INSTRUCTIONS

Cutter Boom Controls

The joystick control can be easily attached to the leg of the operator using the Velcro straps provided.

Always turn off the engine and remove the joystick control from your leg before exiting the skid steer cab to avoid unwanted the movement of the machine or attachments that could cause death or serious injury.

To swing or tilt the cutter head, the auxiliary hydraulics to the cutter drive must be turned on.

During operation you may notice that the cutter speed slows down a little while you are activating the swing or cutter deck tilt. When you have completed swinging the boom or tilting the cutter deck, the cutter will resume to its normal rotation speed.

Engaging Cutter Drive

If this is your first time using this attachment on this machine, check the skid steer's hydraulic oil level and add oil, if necessary, before and after following steps 1- 6 below.

After starting the skid steer, lift the attachment off the ground surface:

1. With the skid steer engine speed just above idle, engage the auxiliary hydraulic flow to the cutter head. Use your machine's "Boom Swing" electric switch to rotate the cutter boom to the right. Stop when the cutter has rotated 90°.
2. Rotate the cutter head back to the straight-ahead position.
3. Rotate the "Cutter Tilt" using the electric control switch until the cutter hits the stop.
4. Tilt the cutter head in the opposite direction until it hits its stop.
5. Return the cutter head to the level position and the cutter boom to the straightforward position. Allow the cutter to run for 30 seconds to purge the air from the system. Turn off the cutter drive, allowing it to

come to a complete stop.

6. Lower the cutter attachment to the ground and turn off the skid steer's engine and exit the operator's compartment.

7. Check the skid steers hydraulic oil level, and add oil if necessary.

8. Inspect the cutter hydraulic plumbing for any noticeable leaks. Correct any leaks before continuing.

9. Restart the skid steer. With the attachment lifted off the ground and the engine throttle set just above idle, engage the cutter drive circuit to start the cutter. Allow the cutter to come up to speed before increasing the engine speed.

Starting the Cutter

Moving or engaging the cutter with bystanders in the area could result in death or serious injury. Before engaging the cutter hydraulics, always make sure the area is clear of bystanders. Engage the cutter drive hydraulics with the prime mover's engine at a low rpm. Slowly raise the skid steer engine speed to the correct and desired cutter speed. Use the skid steer throttle to set the speed; never use a foot throttle when using the cutter.

Stopping the Cutter

When stopping the cutter, lift the cutter slightly and lower the skid steer's engine speed to idle and allow the cutter to slow down. After the cutter has slowed down you may turn the auxiliary hydraulics to the "off" position.

Getting Familiar with the Attachment

Use caution when operating on un-level ground surfaces. The machine could roll over, result in minor or serious injury. Always wear your seat belt when operating this attachment.

Before starting the skid steer engine with this cutter attached, make sure you understand and are familiar with the operation of the brush cutter controls as described in the previous and following sections of this

manual.

Do not overspeed the cutter by allowing more than 20 GPM to the cutter head. This attachment requires 14-20 gallons of flow to cut efficiently.

When operating the cutter, set the skid steer throttle at a speed that produces the required flow. Refer to your skid steer manual or call your local skid steer dealer for additional help, if necessary. Your skid steer dealer can measure the available flow on your machine and recommend a throttle setting that is compatible with this attachment.

To begin with, learn what the cutter head looks like in a level cutting position when you are seated in the skid steer. Knowing what a level cutter head looks like will help you avoid damaging to the cutting blades by cutting too close to the ground surface.

Rotate the boom 90° to the right and learn what the level position looks like when cutting off to the side of the skid steer. Roll out the skid steer's tilt cylinder and notice how it affects the cutter head.

The correct ground speed for cutting with this attachment can be monitored by sound and feel and depends on the material density. If the skid steer engine stalls or the cutting speed is too slow due to excessive load, the ground speed should be decreased.

Listen and feel for any strange vibrations when using the cutter. A bad vibration felt when cutting could indicate a damaged cutting blade or material being cut too fast. Slow down the skid steers ground speed of the skid steer to see if the vibration stops. If it does not, stop the cutter, turn off the skid steer engine and investigate the cause of vibration. Refer to the Troubleshooting section of this manual for further instructions.

Always be aware of your surroundings. When the cutter is rotated 90°, the operator has a much greater distance to the ground. If the cutter creates a vibration when ramping up speed, turn the cutter attachment to the off position and investigate the cause. Refer to the

Troubleshooting section in this manual.

Never operate the cutter when bystanders are within 300' of your working area. Flying debris could result in death or serious injury. Remain alert while watching the cutter, also pay attention to any obstacles or terrain are in front of the cutter boom and prime mover. Maintain a safe speed while cutting.

Cutting brush and tree branches with the cutter in an elevated position could result in death or serious injury if the skid steer becomes unstable. Never raise the cutter more than a few feet off the ground when working on slopes or uneven terrain.

Adjusting Cutter Height & Level

Use the skid steer loader lift to adjust the height of the cutter. The fore & rear leveling can be accomplished by using a combination of the tool cylinder mounted on the boom and the skid steer's attachment tilt cylinders.

When the cutter is at the 0° position (straight in front of the skid steer), the tool cylinder on the boom can be moved to level the deck.

When the cutter is at the 90° position, it can be leveled by using the tool cylinder connected to the attachment, as well as slight variations in the tilt of the skid steer loader.

Swinging Cutter

Keep all persons and objects away from this attachment while it is operating.

Your Articulating Brush Cutter has the capability of rotating 90° to the right of the skid steer's mounting point, or stopping anywhere between 0° and 90°.

Before swinging the boom to the right or back to the center, make sure there are no objects in the way that could hinder the movement of the boom swing.

To rotate the cutter boom, push the joystick right or left for the boom

swing function. To tilt the cutter, move back to adjust the deck.

With moving the skid steer with the boom at 90°, make sure you are aware of any obstacles directly in front of the skid steer or in front of the boom, when moving the skid steer.

Use caution when operating on uneven terrain or any type of sloped surface. Keep the cutter low to the ground when working in these conditions to avoid a roll over that could result in minor or serious injury. Determine a safe cutting pattern before swinging the boom and cutter. Stop the forward movement of the skid steer loader until the boom swings to the desired position until you are fully familiar with the movement of the attachment.

Before Cutting

Inspect the area to be cut and make sure it is free of any utilities, rocks, fence posts, or any other objects that you do not want to cut or that would damage the cutter.

Do not enter into an area to be cut before the cutter rotation come up to the operating speed.

Cutting Tips

Never operate this attachment when bystanders are in proximity of the working area to avoid minor or serious Injury from flying debris.

1. Always inspect the working area before starting the cutter. Locate and mark any utilities, steel posts, rocks or any other objects that could be damaged or cause damage to the cutter during operation. Never assume that the working area is safe and never skip the inspection part before start of operation.
2. Operate at a safe slow-paced speed that will allow you to watch the area ahead of the skid steer and also ahead of the boom and cutter when the cutter is swung away from the straight-ahead position.
3. Make sure you operate the skid steer's engine at a speed that will produce the volume of oil flow required for this attachment.

4. If the cutting speed slows down, reduce your driving speed and allow the cutting deck to reach the proper rotational speed. Mowing too fast in thick material could result in balling of material underneath the cutter deck, which reduces cutting efficiency.
5. Never use the cutter to push, pull, lift or move any type of object or vehicle. Do not use this attachment to "push down" trees.
6. Always allow the cutter to come up to operating speed before moving the attachment into the material to be cut.
7. If material constantly is balling underneath the cutter deck, try tilting the leading edge of the cutter to be about 1" lower than the rear of the cutter deck. This should allow a more efficient material flow under the cutter deck.
8. Use the V-notch in the top of the cutter deck to capture small trees (up to 3" (76mm))for cutting.

Vertical Cutting

Your Articulating Brush Cutter could cut vertically to widen pathways, roadways, or along the edge of a crop field to allow access for tractors and combines.

Vertical cutting can disperse debris over a large area. To avoid an accident that could result in death or serious injury, do not operate the cutter if bystanders are within 300' (91m).

To avoid minor or serious injury, never swing the cutter boom past the side tipping capacity of your skid steer when the cutter is in the raised and vertical position. Know the capability of your machine and notice the terrain you are working on. Raise the skid steer loader arm and tilt the cutter head to the vertical position. Swing the boom to the right to access the area to be cut. Raise and lower the skid steer's lift to trim back over- hanging branches.

VI. HYDRAULIC ELECTRIC CONTROL SYSTEM

Read all safety decals and safety statements in all manuals before beginning any hydraulic connection. Know and obey all OSHA regulations, local laws, and other professional guidelines for your operation. Know and follow good work practices when assembling, maintaining, repairing, mounting, removing, or operating this equipment.

1. Disconnect the hydraulic hose quick coupler from one another and attach the quick coupler to the prime mover as per the instructions in your prime mover operator's manual.

2. Carefully raise the loader and cycle the rollback/dump cylinders to check hose clearances and check for any interference. Operate the hydraulic cylinder(s) on this product and perform the same checks.

3. Cycle the hydraulic cylinder(s) on this product from fully retracted to fully extended several times until all air has been completely removed from the cylinder(s).

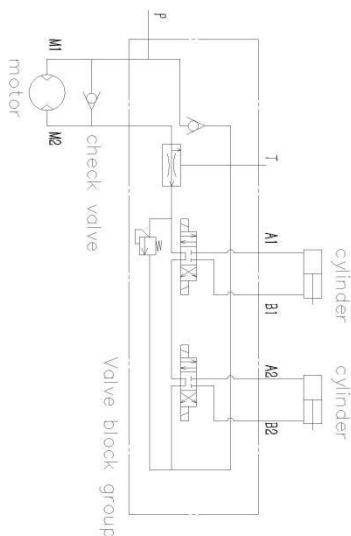

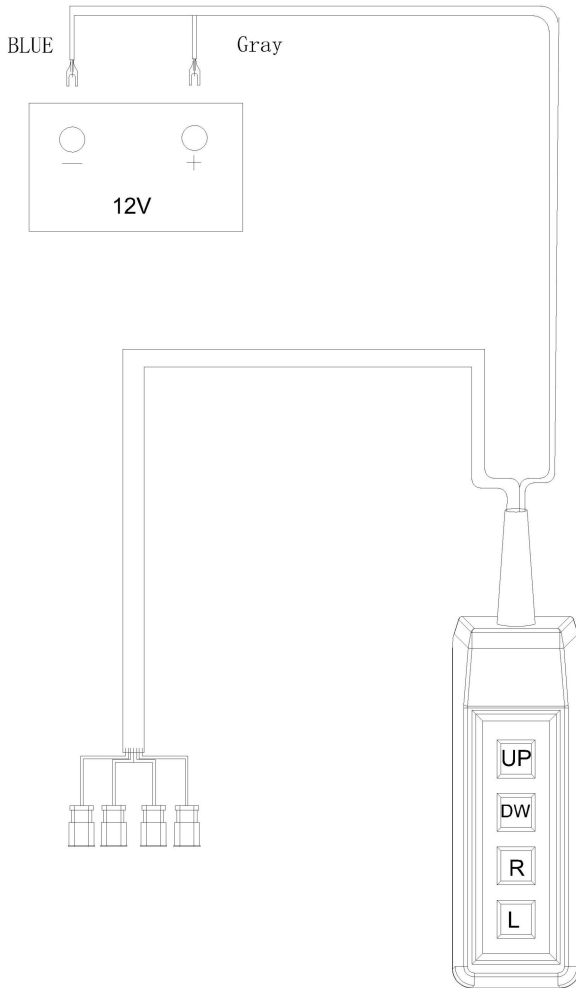

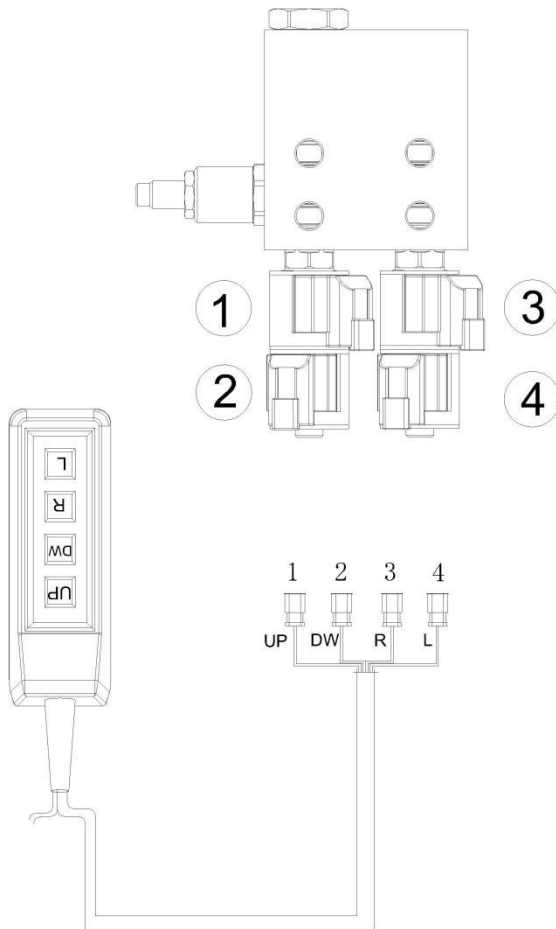

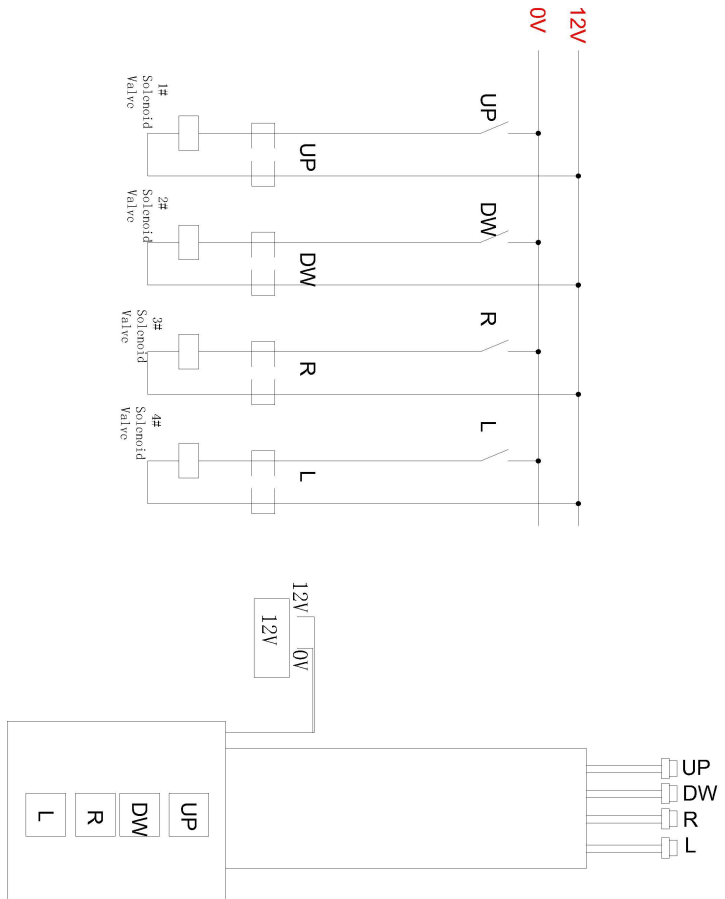

VII. MAINTENANCE

Blade Removal & Replacement

Cutter blades can be very sharp and could cause minor or serious injury if mishandled. Always wear protective gloves and footwear.

Position the cutter attachment with cutter deck in the vertical position so that you can access the blade and holder bracket.

Blades & Holder

Sling the holder from the hoist and remove the bolts from the center of the blade holder. Lower the holder to the ground or a suitable work surface.

Use a cutting torch to remove the head of the blade mounting bolt, and drive the bolt shaft out of the end of the blade holder. Install the new or sharpened blade into position and secure the blade with a new bolt, bushing spacer & nut, and apply red thread lock to the bolt threads.

Repeat this procedure on the other end of the blade before installing the holder back on the attachment. Install new hardware to secure the holder to the cutter drive. Torque the six blade holder bolts to a minimum of 600 lb-ft (813 Nm).

Always service (sharpen or replace) the blades as a set. Never run the cutter with unmatched blades.

Not maintaining your implement correctly could result in minor or serious injury. Keep the implement in top operating condition.

Before Every Use

Check that all fasteners (nuts, bolts, pins, keepers) are in their right place and tightened.

Inspect and replace any worn, torn or missing safety decals.

Pump No.2 lithium or molybdenum disulfide grease into all required areas.

Wait until you see old grease is being flushed out.

Investigate the location of any oil leaks and repair.

After every use, clean off any residual dirt with a garden hose and repeat the grease application.

Every Week

Check the condition of the blades by lifting the cutter attachment off the ground and tilting the attachment back to the 90° position. Lower the attachment to the ground.

Inspect the cutter blades and remove and sharpen them if necessary. Sharp cutter blades will cut more efficiently than dull blades.

After Every Season

Inspect the implement for any loose or worn parts that may need to be replaced prior to the next cutting season.

Visually inspect the cutting blades. Sharpen or replace them, if necessary.

Clean, sand & repaint any area that look worn or scratched to prevent further rusting.

Use an equipment paint from your local hardware store or construction center.

Lubricate all pivot joints. If located in an area near an ocean or other corrosive conditions, apply a thin layer of grease to any exposed cylinder rod surfaces. Wipe the grease from the cylinder rods with a clean rag when taking the attachment out of storage.

Store your implement in a shed or cover it with a water-proof tarp to protect it from the weather. Store in an area not frequented by children.

VIII.TROUBLESHOOTING

Problem	Possible Cause	Possible Solution
Cutter bogs down	Deck is not properly leveled & material is balling under deck	Refer to the leveling instructions found in this manual.
	Dull blades	Remove and sharpen blades.
	Ground speed too fast	Slow down ground speed.
	Cutter speed too slow	Raise engine speed or investigate other low oil flow problems
Vibration felt when running cutter	Missing, loose, damaged or unbalanced cutter blades	Replace blades with new or re-sharpened and equally balanced blades.
	Blade mount damaged	Replace blade mount
	Gearbox loose on the deck	Tighten & torque gearbox mounting bolts. Replace bolts if they are damaged.
	Cutting height too low for cutting in sandy or rocky soils	Raise the cutter height.
Blades get dull too quickly	Blades have contacted solid objects (rocks, steel pipes, etc.)	Clear the cutting area of solid objects before hitting them, or raise the cutter height to clear exposed rock surfaces.

Blades breaking	Excessive shock loads	Avoid hitting solid objects (rock, steel pipes, large tree stumps, etc.).
Hydraulic oil level goes down during operation	Leak at valve, cutter motor or other plumbing	Investigate & repair
	Leaks in skid steer hydraulic system	Investigate & repair
Blades do not spin when flow is activated	Shear bolt between motor and gearbox is sheared	Replace with proper shear bolt specified for this unit.
	Motor or gearbox failed	Disconnect the drive chain between the motor & gearbox. If the blade holder can be turned by hand, motor failure is suspected. Call the factory for further instructions.
	Check valve failure	Remove the check valve from tees, cap the tees and attempt to run the cutter. If the cutter spins, replace the check valve.
Blades turn, but cannot tilt or swing cutter	No electrical power to controller or solenoid valves	Check the in-line circuit fuse. If blown, investigate cause & replace.
		Check the connections at solenoid valves.
		Check that circuit has a good ground.
		Have local skid steer dealer check the Operator Presence System

IX. BOLT TORQUE SPECIFICATIONS

GENERAL TORQUE SPECIFICATION TABLES

Use the following charts to determine bolt torque specifications when specific torques are not given. Always use grade 8.8 or better when replacing bolts.

METRIC BOLT TORQUE SPECIFICATIONS

The following torque values are for use with metric bolt head identification marks as per grade. Hardware that is unplated and either dry or lubricated with engine oil. Reduce torque by 15% when using hardware with extreme pressure lubricants, plating or hard washer applications.

Ⓐ Diameter & Thread Pitch (Millimeters)	Wrench Size	COARSE THREAD				FINE THREAD				Ⓐ Diameter & Thread Pitch (Millimeters)
		MARKING ON HEAD				MARKING ON HEAD				
		Metric 8.8		Metric 10.9		Metric 8.8		Metric 10.9		
		N-m	lbs-ft	N-m	lbs-ft	N-m	lbs-ft	N-m	lbs-ft	
6 x 1.0	10 mm	8	6	11	8	8	6	11	8	6 x 1.0
8 x 1.25	13 mm	20	15	27	20	21	16	29	22	8 x 1.0
10 x 1.5	16 mm	39	29	54	40	41	30	57	42	10 x 1.25
12 x 1.75	18 mm	66	50	94	70	75	55	103	76	12 x 1.25
14 x 2.0	21 mm	109	80	151	111	118	87	163	120	14 x 1.5
16 x 2.0	24 mm	169	125	234	173	181	133	250	184	16 x 1.5
18 x 2.5	27 mm	234	172	323	239	263	194	363	268	18 x 1.5
20 x 2.5	30 mm	330	244	457	337	367	270	507	374	20 x 1.5
22 x 2.5	34 mm	451	332	623	460	495	365	684	505	22 x 1.5
24 x 3.0	36 mm	571	421	790	583	623	459	861	635	24 x 2.0
30 x 3.0	46 mm	1175	867	1626	1199	1258	928	1740	1283	30 x 2.0



LANDHONOR INDUSTRY

Tel: 1-800-649-8017

Business: sales@landhonor.com

Service: service@landhonor.com

Website: www.landhonor.com